



User Instructions

LAMONA

Exclusive to Howdens Joinery Co.

Register
my appliance

www.howdens.com/appliance-registration

Register my appliance

Register your Lamona appliance purchased from Howdens Joinery to allow us to easily contact you in the event of important product updates at:

www.howdens.com/appliance-registration

LAMONA

Exclusive to Howdens Joinery Co.

Welcome

Dear Customer

Congratulations on your choice of dishwasher which has been designed to give you excellent service.

- Please read the User Instructions to ensure safe operation of the dishwasher.
- Please keep these instructions in a safe place for your future reference.
- If you have any questions, or if you are not sure about any information contained in this booklet please contact us - details at the end of the User Instructions

NOTE: Due to the quality control processes during production, there may be some water left in your machine. This does not cause any damage.

Preparation before use: It is recommended that the dishwasher is operated on the NORMAL 60°C program.

This appliance is intended to be used in household and similar domestic applications, see guarantee for definition of domestic use*.

Throughout this manual the following symbols are used.

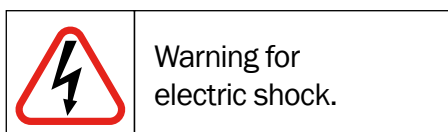
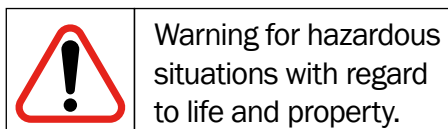

Product information correct at the time of publication in September 2016.

The company has a policy of continuous product development and reserves the right to change any products and specifications given in this manual. Subject to the Terms and Conditions of Trading, a copy of the Howdens Joinery Terms and Conditions is available upon request.

Contents

Register my appliance	p.2
Welcome	p.3
Dishwasher overview	p.5
Safety information	
Children and vulnerable people safety	p.6
General safety	p.6
Installation	p.6
Electrical connection	p.6
Water connection	p.6
Use	p.7
Service	p.7
Disposal	p.7
Fitting a different electric plug	p.7
1 - Installation of dishwasher	p.8
2 - Before first use	p.8
Check water hardness	p.8
Set water hardness program	p.9
Adding dishwasher salt	p.10
Adding rinse aid	p.10
3 - Daily use	p.11
Before starting a program	p.11
Unloading the dishwasher	p.11
Care and cleaning	p.11
4 - Operating the dishwasher	p.12
Loading the dishwasher	p.12
Folding shelves	p.13
Upper basket height adjustment (unloaded)	p.13
Spray arms	p.13
Adding the detergent	p.14
Choose a program	p.15
Program the dishwasher	p.16
Opening the door whilst operating	p.17
Program ends	p.17
5 - Cleaning the dishwasher	p.17
Cleaning the dishwasher	p.17
Cleaning the filters	p.18
Cleaning the upper and lower spray arms	p.18
6 - Detergent use	p.19
7 - Before calling for service/trouble shooting	p.20
8 - Guarantee	p.22
9 - Product fiche	p.23
10 - Specifications	p.23

Dishwasher overview

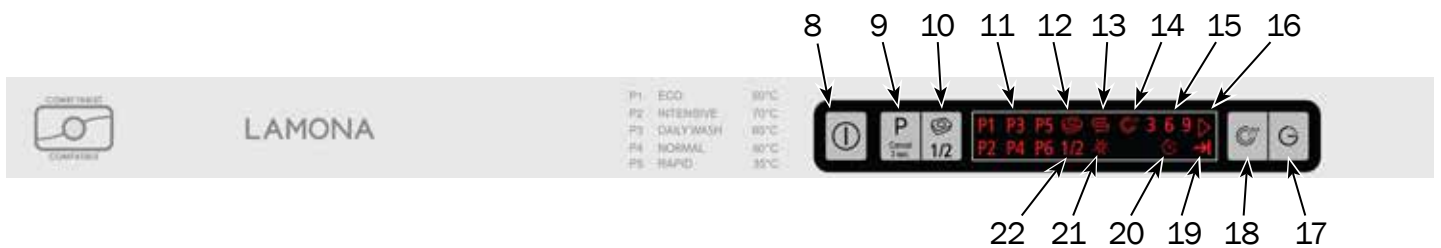
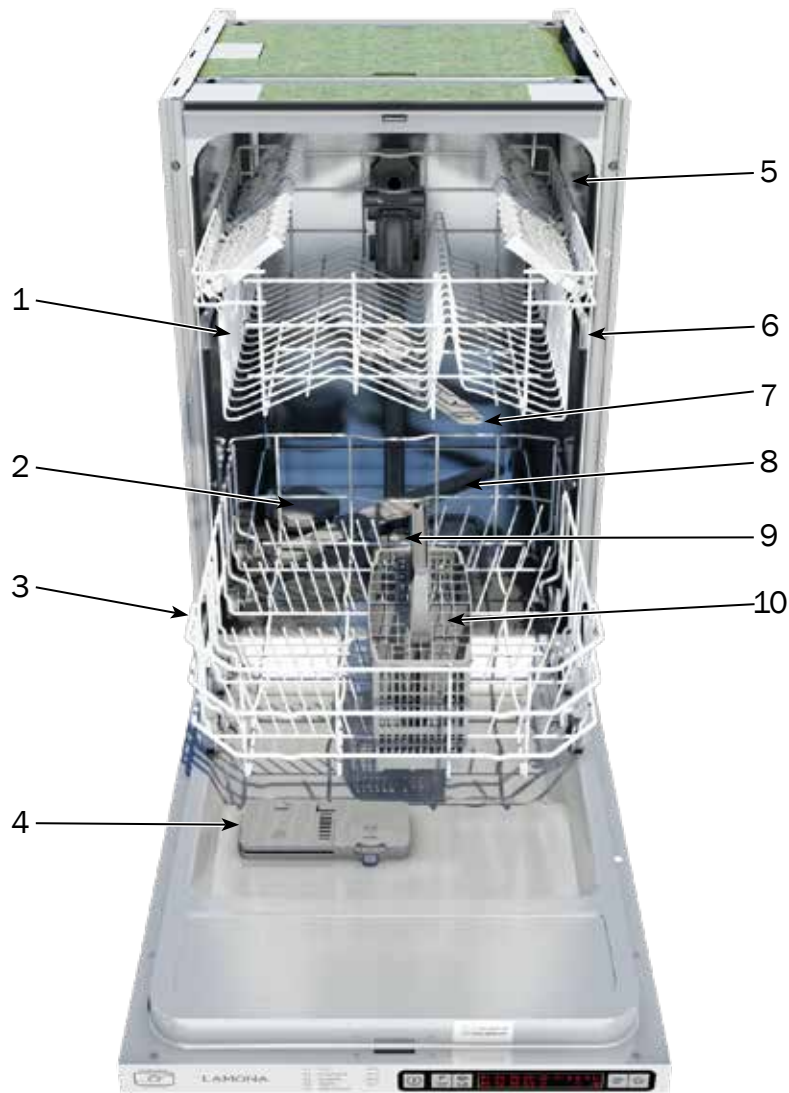

- | | |
|--|-----------------------------------|
| 1. Upper spray arm | 12. Combi tablet indicator |
| 2. Lower basket | 13. Salt level indicator |
| 3. Cutlery basket | 14. Super rinse indicator |
| 4. Detergent and rinse aid dispenser | 15. Time delay indicator |
| 5. Upper basket | 16. Start indicator |
| 6. Lower spray arm | 17. Time delay button |
| 7. Filters | 18. Super rinse button |
| 8. On / Off button | 19. End of program indicator |
| 9. Program selection/Cancel (3 seconds) button | 20. Time delay function indicator |
| 10. Half load/Combi tablet button | 21. Rinse aid indicator |
| 11. Program indicator | 22. Half load indicator |



 Before the installation and use of the dishwasher, carefully read these instructions. The manufacturer is not responsible if an incorrect installation and use causes injuries and/or damage. Always keep the instructions with the dishwasher for future reference.

Children and vulnerable people safety

- This appliance can be used by children aged from 8 years and above and persons with physical, sensory or mental capabilities or lack of experience and knowledge if they have been given supervision or instruction concerning use of the appliance in a safe way and understand the hazards involved.
- **Do not** let children play with the appliance.
- Keep all detergents away from children.
- Keep children and pets away from the appliance door when it is open.
- Cleaning and maintenance shall not be made by children without supervision.

General safety

This appliance is intended to be used in household and similar applications.

- **Do not** change the specification of this appliance.
- The operating water pressure (minimum and maximum) must be between 0.003Mpa - 1Mpa (0.3 - 1.0 Bar).
- The maximum number of place settings is 12.
- Put knives and cutlery with sharp points in the cutlery basket with the points down or in a horizontal position.
- **Do not** keep the appliance door open without supervision to prevent tripping or falling over it.
- Before maintenance, switch off the appliance and disconnect the mains plug from the mains socket.
- **Do not** use steam cleaners or jet washers to clean the appliance.
- The ventilation openings in the base (if applicable) must not be obstructed.
- The appliance is to be connected to the water mains using the new hose-set supplied with the appliance. **Do not** re-use old hose-sets.

Installation

- Remove all the packaging.
- **Do not** install or use a damaged appliance.
- **Do not** install or use the appliance where the temperature is less than 0°C.
- Obey the installation instructions supplied with the appliance.
- Make sure that the appliance is installed below and adjacent to safe and solidly fixed structures.

Electrical connection

 **WARNING!** Risk of fire and electric shock.

- The appliance must be earthed.
- Make sure that the electrical information on the rating plate agrees with the power supply. If not, contact an electrician.
- **Do not** use multi-plug adapters and extension cables.
- Make sure not to cause damage to the mains plug and to the mains cable. Should the mains cable need to be replaced, this must be carried out by a **LAMONA** Authorised Service Agent or a suitably qualified person.
- Connect the mains plug to the mains socket only at the end of the installation. Make sure that there is access to the mains plug after the installation.
- **Do not** pull the mains cable to disconnect the appliance. Always pull the mains plug.
- This appliance complies with all relevant E.U. Directives.
- The appliance has a 13amp mains plug. If it is necessary to change the fuse in the mains plug, use fuse: 13amp ASTA (BS 1362).

Water connection

- Make sure not to kink or damage the hoses during installation.
- Before you connect the fill hose to the appliance; let some water flow through to ensure all debris is removed.
- We suggest you connect the fill hose and open the water valve before pushing the appliance into position.

- Check for leaks during and after installation and after first use.
- If the water inlet hose is damaged, immediately close the water supply valve and disconnect the mains plug from the mains socket.

Use

- **Do not** sit or stand on the open door.
- Dishwasher detergents are hazardous. Obey the safety instructions on the detergent packaging.
- **Do not** drink the water in the appliance.
- **Do not** remove the dishes from the appliance until the program is completed. There may be detergent on the dishes.
- The appliance may release hot steam if you open the door while a program is in operation.
- **Do not** put flammable products or items that are wet with flammable products in, near or on the appliance.
- **Caution:** If removing dishes before or immediately after the program has ended be aware that the dishes may be hot.

Service

- Contact the Depot or Helpline for any Service requirements. We recommend only the use of original spare parts.
- When you contact a **LAMONA** Authorised Service Agent, ensure that you have the following information from the rating plate.
- Model:
- Serial Number:

Disposal

 **WARNING!** Risk of injury or suffocation.

- Disconnect the appliance from the mains supply.
- Cut off the mains cable and discard it safely.
- Disable the door catch to prevent children and pets becoming trapped in the appliance.
- Contact local council for safe disposal.

Compliance with WEEE Directive and Disposal of the Waste Product

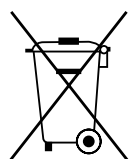

This product complies with EU WEEE Directive (2012/19/EU). This product bears classification symbol for waste electrical and electronic equipment (WEEE). This product has been manufactured with high quality parts and materials which can be reused and are suitable for recycling. **Do not** dispose of the waste product with normal domestic and other wastes at the end of its service life. Take it to the collection centre for the recycling of electrical and electronic equipment. Please contact your local council authority to learn about these collections.

 This appliance complies with all relevant EU Directives

Fitting a different electric plug

As the colours of the wires in the mains lead of this appliance may not correspond with the coloured markings identifying the terminals in your plug proceed as follows, (see diagram).

1. Connect the green-yellow or green (earth) wire to the terminal in the plug marked 'E' or with the symbol  or coloured green and yellow or green.
2. Connect the blue (neutral) wire to the terminal in the plug marked 'N' or coloured black.
3. Connect the brown (live) wire to the terminal in the plug marked 'L' or coloured red.

With alternative plugs a 13 A fuse must be fitted either in the plug or an adapter in the main fuse box.

If in doubt contact a qualified electrician.

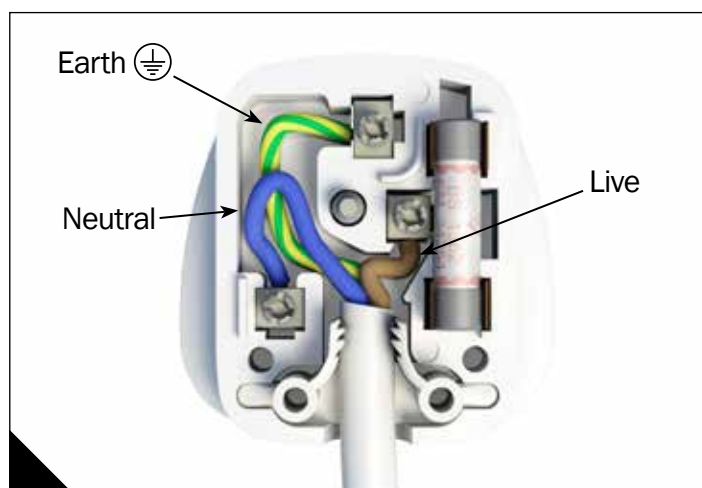

1 - Installation of dishwasher

Separate Installation Instructions are provided with your dishwasher.

Please follow these installation instructions in order to assemble and install your dishwasher easily and correctly.

- After unpacking your dishwasher, check for any possible transportation damage.
- Never install and use a damaged dishwasher. If your dishwasher is damaged contact your supplier.
- Always have your dishwasher installed by a suitably qualified person.
- Any repairs or service work on this dishwasher should only be carried out by a **LAMONA** Authorised Service Agent.
- Unauthorised repairs are dangerous and will lead to the cancellation of your guarantee.
- Make sure the electricity and water connections are in compliance as stated in the Installation Instructions.

2 - Before first use

1. Check water hardness and set level.
2. Fill the salt container, see 'Adding dishwasher salt'.
3. Fill the rinse aid dispenser, see 'Adding rinse aid'.
4. Open the water tap.
5. To remove any manufacturing residues that may still be inside the dishwasher, select and run the NORMAL 60°C program.
Do not use detergent and **do not** load the baskets.



Check water hardness





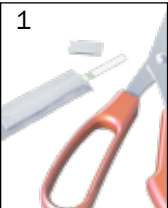

The dishwasher has a special water softening system to remove the hardness of the tap water.

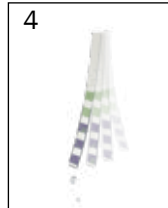
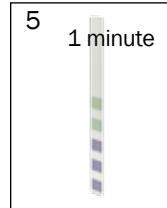
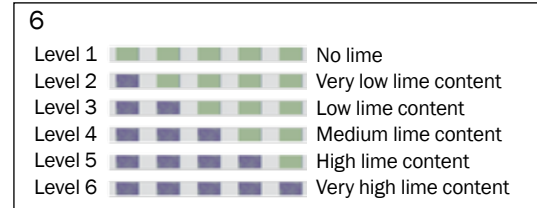
Make sure the current setting of water softener agrees with the hardness of the water supply.

Determine water hardness level by using the test strip provided.

Test strip

					
1 Remove the test strip from the packet.	2 Let the water flow from your tap for 1 minute.	3 1 second Fill a glass with tap water and dip the test strip into the water and stir around.	4 Take the test strip out of the water and shake.	5 1 minute Hold for 1 minute.	6 Level 1 No lime Level 2 Very low lime content Level 3 Low lime content Level 4 Medium lime content Level 5 High lime content Level 6 Very high lime content Set the water hardness level of the dishwasher according to the result shown by the test strip.

Hardness level	Water hardness °dE	Water hardness program setting
Level 1 	0-5	P1
Level 2 	6-9	
Level 3 	10-15	P2
Level 4 	16-19	P3
Level 5 	20-24	P4
Level 6 	25-62	P5

Set water hardness program

Setting the correct water hardness program will increase washing efficiency.

Switch **On**



Press and hold



Press and hold until indicator flashes



Select current water hardness level



Select new water hardness level



Switch **Off** to save new water hardness level



Adding dishwasher salt

Before first use pour one litre of water into the salt container and then completely fill salt container with dishwasher salt.

Some water and salt may spill out of the container. It is recommended to use a rinse program or complete a wash cycle to remove any spilled salt and prevent possible corrosion.

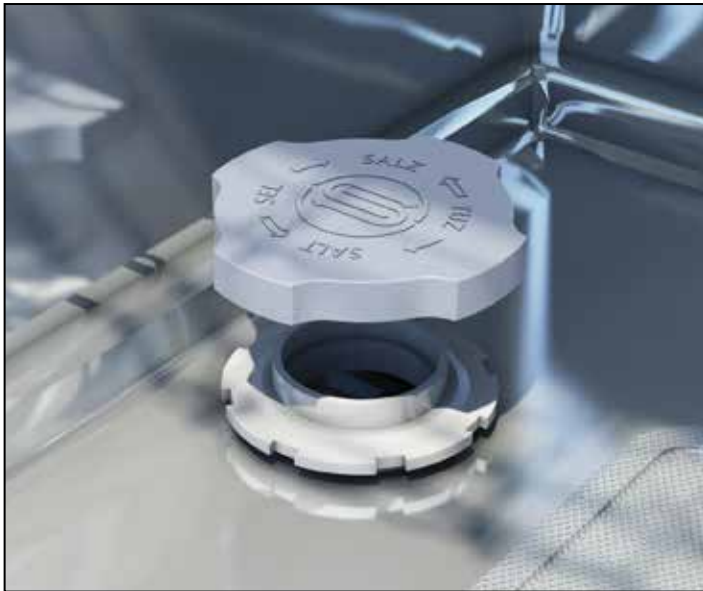

Adding rinse aid

The rinse aid helps to dry the dishes without streaks and stains. It is automatically released during the hot rinse phase.

Adjust the setting to achieve best results by turning the dial.



3 - Daily use

1. Open the water tap.
 2. Load the dishwasher.
 3. Add the detergent.
 4. Press the On/Off button to activate the dishwasher.
 5. Select and start the correct program for the type of load and degree of soil, (if the dishwasher is in program selection mode and the salt or rinse aid indicator is on, fill as necessary);
Ensure the correct quantity of detergent is used.
- Place light items in the upper basket. Make sure these items **do not** move.
 - Make sure that the spray arms can move freely and are not obstructed before you start a program.

Before starting a program

Make sure that:

- Filters are clean and correctly installed.
- The cap of the salt container is tight.
- The spray arms are not obstructed or clogged with food debris.
- There is dishwasher salt and rinse aid.
- Baskets are correctly loaded.

Unloading the dishwasher

- Let the tableware cool before you remove from the dishwasher. Items may be hot.
- First remove items from the lower basket, then from the upper basket.

NOTE: At the end of the program water may still remain on the sides and on the door of the dishwasher and on the tops of cups/bowls etc..

Care and cleaning

 **WARNING!** Before maintenance, switch off the dishwasher and disconnect the mains plug from the socket.

- Dirty filters and clogged spray arms decrease the washing efficiency.

Check regularly and clean, if necessary.

4 - Operating the dishwasher

Loading the dishwasher

! Ensure all items are dishwasher safe.

- Remove large scraps of food from the dishes before placing in the dishwasher.
- Place large or heavily soiled items in the lower basket.
- Place small, light or delicate articles in the upper basket.
- Place forks, small and medium sized knives and spoons in the cutlery basket.
- Place tall, narrow items in the middle of the baskets.
- Long-stemmed glasses should lean against the basket or the support shelves and not against dishes.

! DO NOT allow tall glasses to rest against each other because of damage during the wash program.

- Always arrange saucepans, cups and glasses etc. upside down.

Upper basket

1. Glasses
2. Saucers
3. Dessert bowl
4. Cups
5. Long utensils

Upper basket

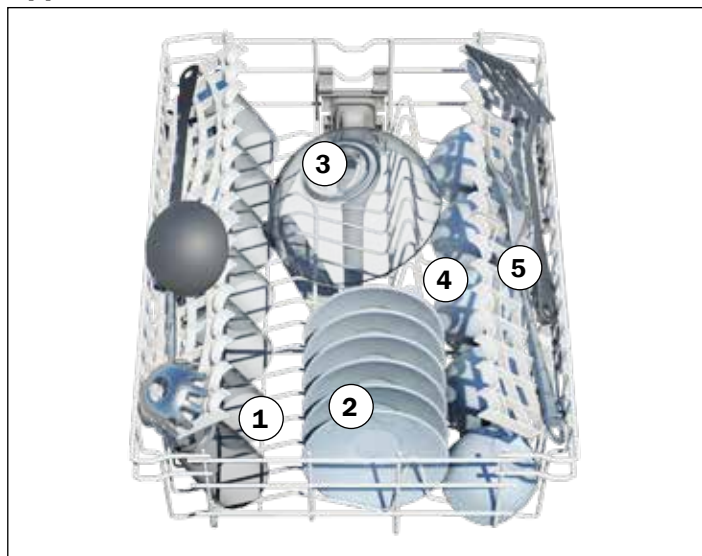

Lower basket

6. Pan lids
7. Side plates
8. Serving dishes
9. Serving bowl
10. Cutlery
11. Dessert bowls
12. Pans
13. Dinner plates

Lower basket

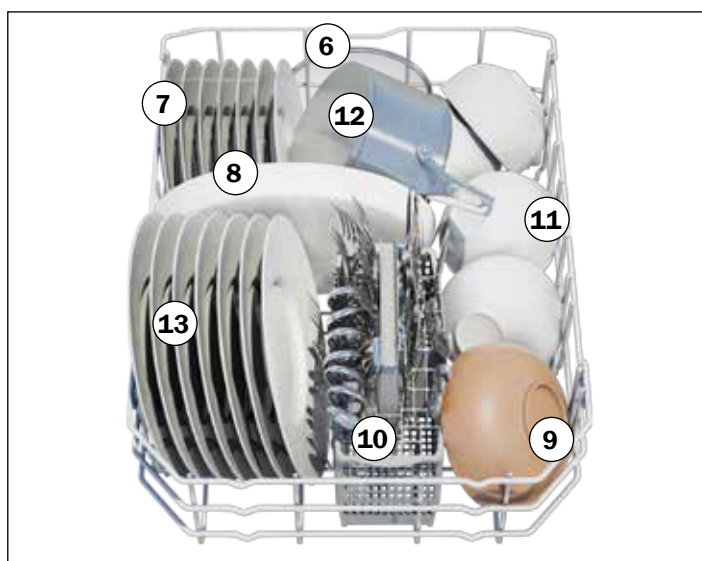

Cutlery basket

- Use the cutlery basket lid to support large items.
- Place sharp or pointed items face down in the cutlery basket.

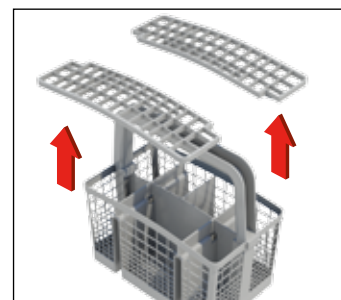

- **! DO NOT** allow cutlery to protrude out of the sides of the cutlery basket.

Folding shelves

Fold the shelves in the upper basket when you need more space for larger items, **(A)** and **(B)**.

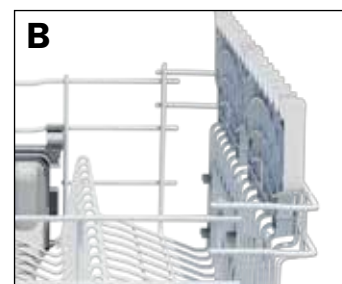
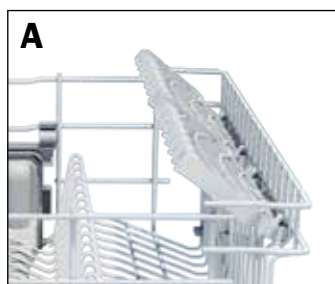

Upper basket height adjustment (unloaded)

 **DO NOT** adjust the height when loaded with dishes.

To adjust the height of the upper basket.

- Release the latches on both the right and left tracks by turning them outwards, **(A)**.
- Pull the basket completely out.
- Insert the upper wheels into the track to lower the basket, **(B)**.
- Lock the basket by turning the latches inwards, **(C)**.

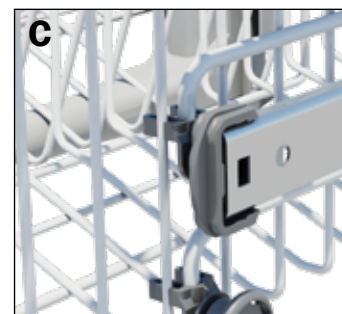
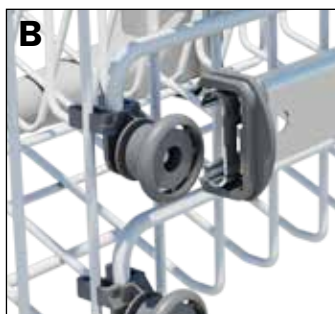
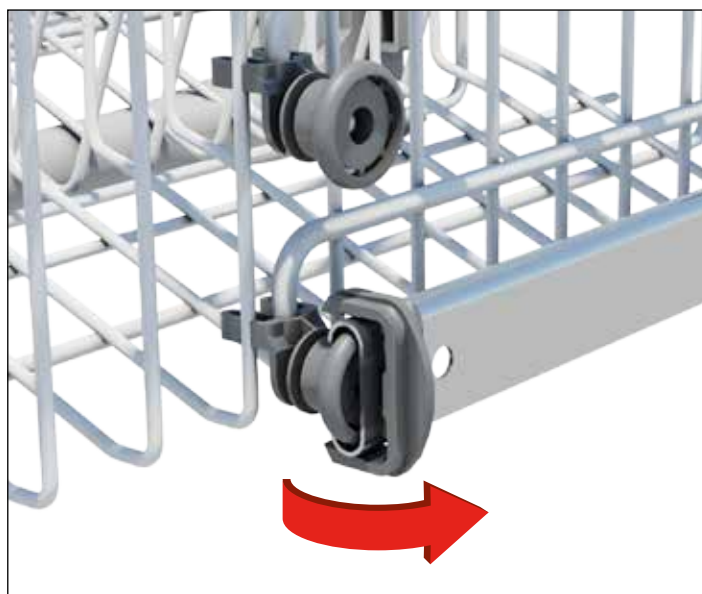

Spray arms

- Check that the upper and lower spray arms can rotate freely,

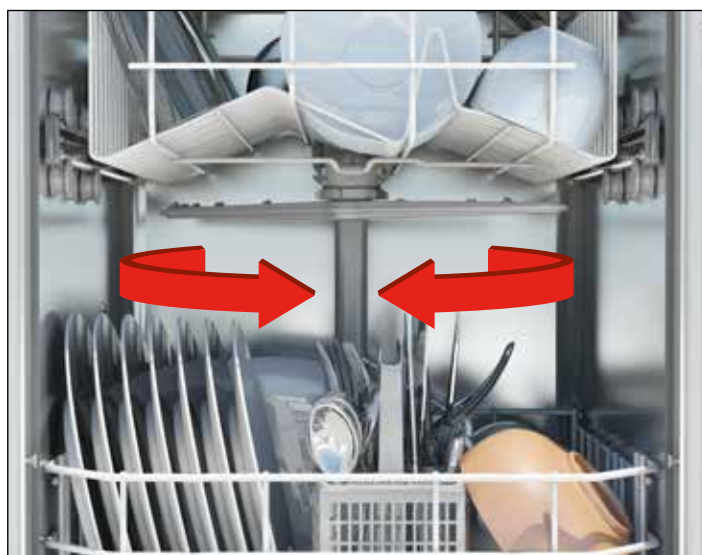

Adding the detergent

When using a powder

- Full load and the dishes are relatively dirty, fill the main container (A) to **25cm³** level.
- Half load and the dishes are slightly dirty, fill the main container (A) to **15cm³** level.
- Dishes that are heavily soiled also fill the small container (B) up to **5cm³**.
- After filling the detergent holder, close the container lid (C) and ensure you hear a clicking sound.
- During the wash program the detergent will dispense automatically and the lid (C) will remain open.
- **DO NOT** use detergent when using the pre-wash program.

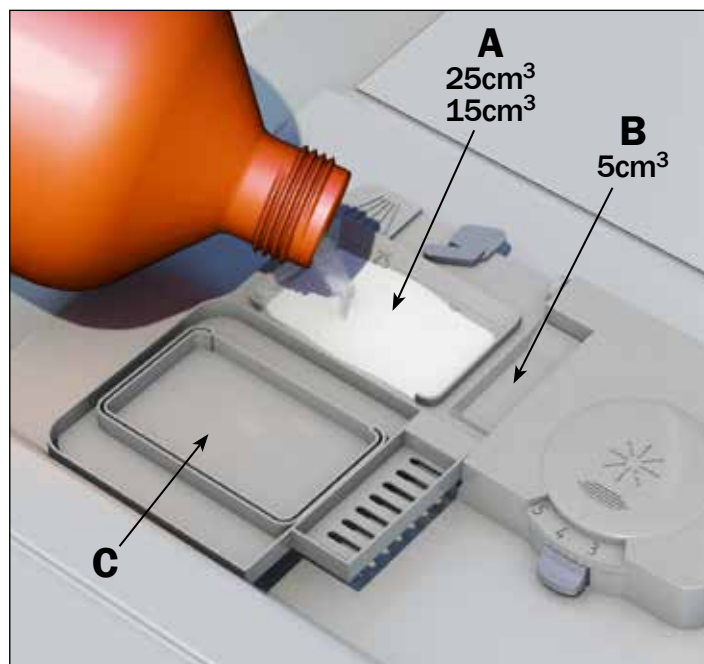

When using tablets

- Place tablet in main container (A).
- Close the container lid (C) and ensure you hear a clicking sound.

If you are using combi tablets read the manufacturer's recommendations in order to determine where the tablets should be placed inside the dishwasher.

! **Caution: Never put washing-up liquid in the dishwasher.**

Detergent residues

- Regular use of low temperature washes and/or short duration programs can lead to a residue build up. We recommend running a service wash at the highest temperature every 3 - 4 months with the dishwasher empty and without detergent.
- **DO NOT** run the auto program.

For full detergent information, see 'Detergent use'.

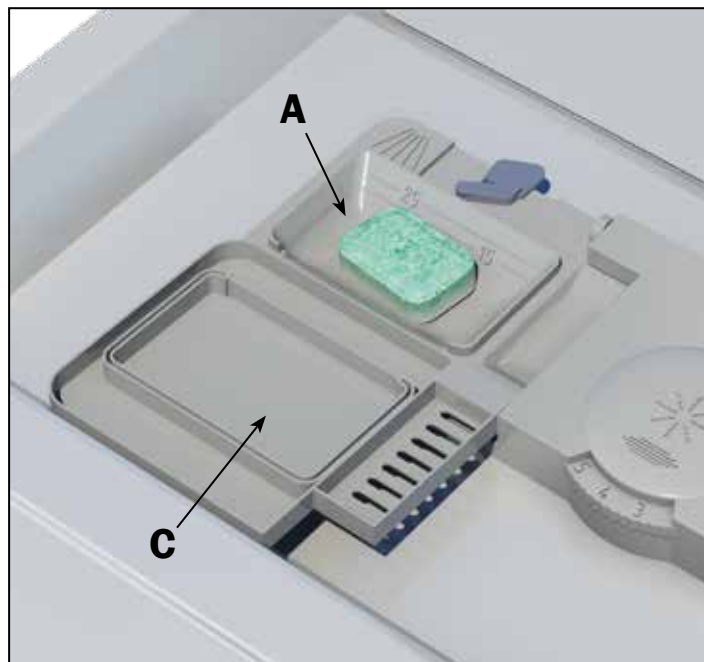

Choose a program

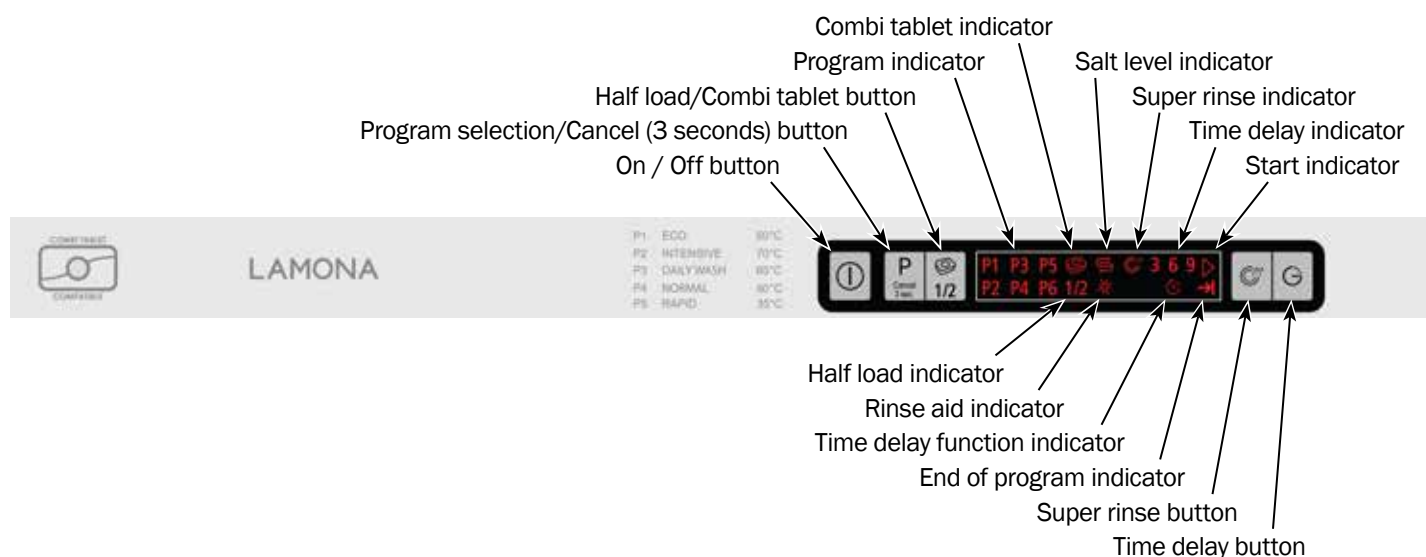

Programs and temperatures.	Cycle selection information.	Degree of Soiling	Detergents A=25cm ³ /15cm ³ B=5cm ³	Prewash	Wash	Dry	Time (mins)	Water (Litres)	Energy (Kwh)
P1 eco* 50°C	Most economic program for medium soiled dishes that are kept waiting.	Medium	A + B	+	+	+	210	13	0.83
P2 INTENSIVE 70°C	Heavily soiled dishes, pots and pans requiring hot pre-wash.	High	A + B	+	+	+	115	14.4	1.32
P3 DAILY WASH 65°C	Daily wash program for normally soiled dishes.	Medium	A + B	-	+	+	96	10.6	1.04
P4 NORMAL 60°C	Normally soiled dishes, fast cleaning in 58 minutes.	Low - Medium	A + B	-	+	+	58	10.6	1.10
P5 RAPID 35°C	Lightly soiled dishes that are scraped or pre-cleaned.	Low	A	-	+	-	30	10.2	0.77

- * Reference program for the Testing Institute and energy labelling. Testing program: Eco 50°C as compliant to EN 50242 international norms.
- Values declared on the product or in the User Instructions / program chart and quick reference sheet supplied with the appliance are obtained in tests performed under controlled laboratory conditions and these tests are as defined in relevant standards. These figures may vary depending on how soiled the dishes are, the water hardness level and other factors. Temperature changes exceeding 15°C may also effect these figures.
- Due to the continual improvement through research and development, specifications and design may change without prior notice.

Maximum plate size (cm)	
Upper basket	Lower basket
25	31

Program the dishwasher

Power On/Off ①



Select program ②



Option (function key) -
Select combi tablet



Option (function key) -
Select 1/2 load



Option (function key) -
Super rinse



Check salt and rinse aid



Option (function key) -
Select time delay
start 3/6/9hrs



Close the door ③ program will start.

End of program
indicator



To cancel a program.
Press and hold for three
seconds, close door.
Machine pumps
out and stops.



To cancel a function.
Press and hold until
the indicator light
disappears, close door.

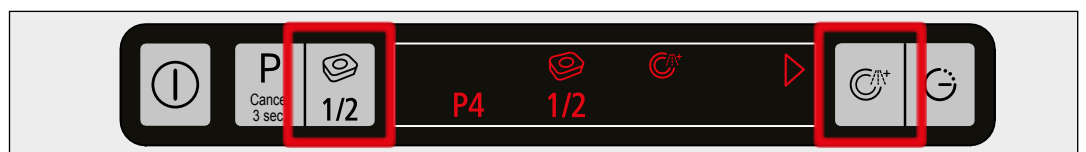

Opening the door whilst operating

If you open the door while a program is running, the dishwasher stops immediately. When you close the door, the dishwasher continues from the point of interruption.

 **Caution:** Care must be taken when opening the door, as steam and water will escape.

 **Caution:** Water may be very hot.

 **Caution:** Just after the dishwasher has started the selected program and you want to include another item to be washed, open the door carefully. Care must be taken when opening the door, as steam and water will escape. Load the item and close the door. The dishwasher will resume operation.

Program ends

An audio signal with an interval of 10 seconds warns you to switch your machine off when the selected washing program ends. This audio signal warns you for a duration of 5 minutes and then turns off.

 **Caution:** Care must be taken when opening the door, as steam and water will escape.

- Press the '**On/Off button**' when the program as finished. The indicator lights will go off.
- Unload the dishwasher.

5 - Cleaning the dishwasher

Cleaning the dishwasher

For the efficient operation of your dishwasher, check and clean the filters and spray arms regularly.

 **Caution:** Always unplug the dishwasher and turn off the water supply before cleaning.

- Clean spray arms and filters at least once a week.
- Clean the door seal using a neutral detergent and damp cloth.
- Clean the control panel using a slightly damp cloth.

 **Caution: Do not** use abrasive detergents.

If the dishwasher is not going to be used for a long period of time.

- Switch off.
- Turn off the water supply.
- Clean and leave the door ajar.

Cleaning the filters

There are three different filters in your machine.

Main filter

Coarse filter

Micro filter

- Remove filter assembly by turn the micro/coarse filter anti-clockwise.
- Lift the micro/coarse and main filter out.
- Press the two tongues inwards and pull out the coarse filter.
- Clean all three filters under running tap water using a brush.
- Replace the coarse filter into the micro filter. Ensure the marks align.
- Replace the micro/coarse and main filter.
- Turn micro/coarse filter clockwise until a clicking sound is heard.

It is important that you fit the filters correctly.

⚠ Caution: The dishwasher must not be used without filters.

Incorrect repositioning of the filters will produce poor washing results.

Cleaning of the filters is vital to ensure correct operation of the machine.

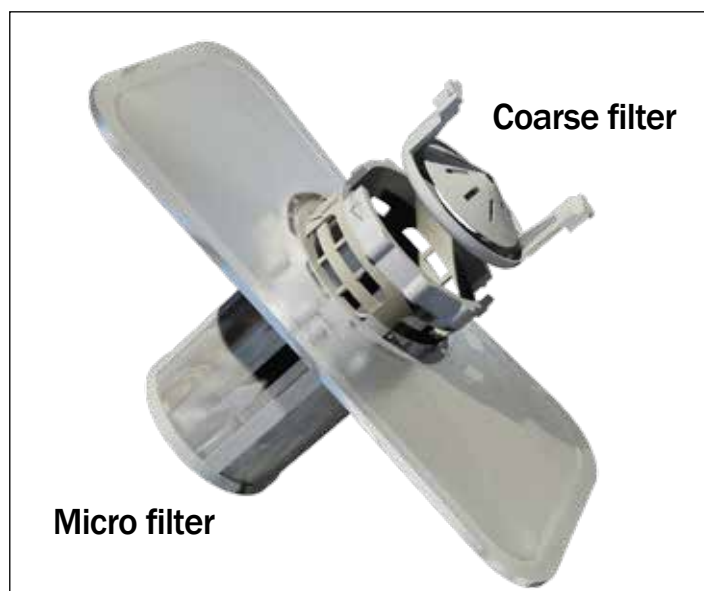
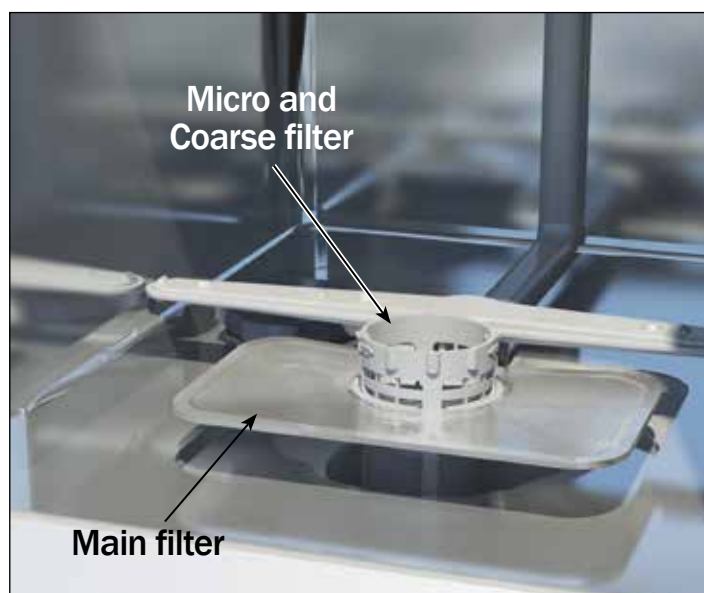

Cleaning the upper and lower spray arms

Upper spray arm

- Turn the nut anti-clockwise and remove the spray arm.
- Flush away food debris under running water.
- Use a toothpick or similar to remove food debris.
- Replace the spray arm and screw the nut clockwise until a clicking sound is heard.

Lower spray arm

- Remove the spray arm from its slot by releasing the catches and pulling it upwards.
- Flush away food debris under running water.
- Use a toothpick or similar to remove food debris.
- Replace the spray arm.



6 - Detergent use



Any brand of powder, gel and combi tablets that have been designed for household dishwashers, may be used.

Keep detergents in a cool and dry place and out of the reach of children.

Detergent must be added to the container before each use.

Detergent overdose may cause scratches on your dishes and there may be traces of detergent left in your machine.

Three types of detergent are available

- Phosphate and containing chlorine.
- Phosphate containing no chlorine
- Neither containing phosphate nor chlorine

New compact powders are generally phosphate-free. As phosphates have water softening properties, we suggest you add salt to the salt container even if the hardness of your water is as low as a 6 clarke degrees.

In hard water areas if a phosphate free detergent is used, white marks on the dishes and glasses may be observed. It may be prevented by increasing the amount of detergent.

Detergents without chlorine have less bleaching effect. Coloured stains may not be completely removed. This may be prevented by increasing the amount of detergent, using a program with a higher wash temperature or using a detergent with chlorine.

Warning: Two-in-one and three-in-one detergents.

You will obtain the best results from your dishwasher if you use separate detergent, rinse aid and water-softening salt.

Detergent manufacturers also produce combined detergents known as 'two-in-one' and 'three-in-one'.

Two-in-one: These products contain detergent and either rinse aid or water-softening salt.

Three-in-one: These products contain detergent, rinse aid and water-softening salt.

In general, you will obtain satisfactory results from combined detergents only under specific usage conditions. These detergents contain predetermined amounts of rinse aid and/or softening salt. This means that you cannot adjust the amount of water-softening salt and rinse aid required to suit the water hardness level in your home.

You should bear the following points in mind when using such detergents:

- Be sure to check the specifications of the product you are using and whether it is a combined product or not.
- Follow the instructions on the packet when using these products.
- The use of these products at the correct appliance settings will ensure economical use of salt and/or rinse aid.
- If the detergent is in tablet form, never place these in the internal section or cutlery basket of the dishwasher. Always place the tablets in the detergent dispenser of the detergent holder.

Using three-in-one detergent, softening salt and rinse aid.

- These detergents will not give you the same drying performance that you can obtain by using separate detergent, salt and rinse aid. To increase the drying performance:
- Put your appliance's rinse aid setting at "1" and apply rinse aid. When the rinse aid is used up, add more rinse aid to the rinse aid dispenser.
- If you use combined detergents with a rinse aid setting higher than 1, hand contact may leave rainbow-coloured water stains on the washed items and inside the machine.
- If you use combined detergents without adding salt, lime scale may form especially on glasses. To avoid lime scale formation:
- Put your appliance's water softener setting at "1" and add salt. When the salt is used up, add more salt to the water softener.

Using two-in-one detergent: detergent and softening salt.

- These detergents **do not** contain rinse aid so you need to use the rinse aid setting as described in the manual, making sure that there is rinse aid in the rinse aid dispenser with every wash and that you refill the rinse aid dispenser with rinse aid every time it is empty.

Using two-in-one detergent and rinse aid.

- These detergents will not give you the same drying performance that you can obtain by using separate detergent, salt and rinse aid. To increase the drying performance:
- Put your appliance's rinse aid setting at "1" and apply rinse aid. When the rinse aid is used up, add more rinse aid to the rinse aid dispenser.
- If you use combined detergents with a rinse aid setting higher than 1, hand contact may leave rainbow-coloured water stains on the washed items and inside the machine.
- These detergents **do not** contain softening salt so you need to use the softening setting as described in the manual, making sure that there is salt in the water softener with every wash and that you refill the water softener with salt every time it is empty.

Important warning.

Should you encounter a problem that has previously never occurred after you start using these detergents, contact the detergent manufacturer directly. You will find contact details on the packet.

If you stop using this kind of detergent:

- Ensure that the salt and rinse aid dispensers are full.
- Put the water hardness setting at the highest level and run a wash cycle with the appliance empty.
- After washing while empty, return the water hardness setting to the correct level for your mains water hardness shown in the manual.
- Put the rinse aid setting at the correct level.

7 - Before calling for service/trouble shooting

Before calling the **LAMONA** Service Line check the following and trouble shooting guide below.

- Is the machine plugged in and switched on?
- Is the circuit breaker switch on?
- Is the water supply valve turned on?
- Is the dishwasher door closed firmly?
- Are the filters clogged?
- Is the detergent dosage and/or rinse aid sufficient?
- Is there enough salt in the water softener?
- Are the spray arms blocked and turning freely?

TROUBLE SHOOTING GUIDE

Symptoms	Possible causes	Solutions
Spotting / filming / poor cleaning results.	Insufficient amount of detergent.	Increase the amount of detergent, especially when washing full loads or in hard water areas.
	Hard water areas.	Increase water softener dosage. Use additional detergent, increase rinse agent dosage.
	Spray arm needs cleaning.	Check the nozzle holes in the spray arms are not blocked with food debris. Check and clean them periodically.
	Improper loading.	Follow instructions for use and loading procedures. Place dishes so that water spray reaches all soiled surfaces. Do not overcrowd the baskets since this will block the water spray.
	Insufficient water fill.	Check mains water pressure. Fill hose kinked.
	Filter system needs cleaning.	Remove any accumulated food debris. Check and clean filters periodically.
	Over sudsing - pre-washing with a liquid dish washing detergent.	Rinse items thoroughly before putting them into the dishwasher to remove dish washing detergent.
Small particles (food or detergent) left on items.	Water not reaching surfaces, dishwasher overcrowded.	Check to be sure water action is not blocked by dishes. Check filter system for accumulated or deposited food or detergent. Load dishwasher correctly. Keep filter system clean.
	Insufficient water fill.	Check mains water pressure. Fill hose kinked.
	Powder detergent stored too long or under adverse conditions.	Use powder detergent within one or two months after purchase. Open one box at a time. Always close pouring spout after each use. Store in a cool, dry place.
	Rinse aid supply depleted.	Add rinse aid to the dispenser.
Pitting of steel items.	Prolonged contact with salty or high acidic foods or with undissolved or highly concentrated detergent.	Remove spots with silver polish. Rewash. Wash soon after use, or pre-wash items if they will not be washed right away. Do not overload cutlery basket. Avoid spilling or pouring detergent directly on flatware. Make sure dispenser cup is properly closed.
Dishes not dry.	Improper loading.	Load so that all items are properly tilted for good drainage. Avoid nesting of dishes and/or silverware.
	Rinse aid supply depleted.	Add liquid rinse aid.

TROUBLE SHOOTING GUIDE

Symptoms	Possible causes	Solutions
Scratches on glassware.	A water or chemical reaction with some glassware. Usually caused by some combination of soft or softened water and alkaline washing solutions reacting with the glassware. Can be accelerated by poor rinsing, overloading and excessive temperature.	The condition may not always be preventable. To minimise the possibility of etching, use minimum amount of detergent.
		Use of the appropriate program.
		Use of a rinse aid may also help.
Detergent cakes in detergent dispenser.	If using a powder detergent, there may be dampness in the dispenser.	Make sure dispenser is dry before adding powder detergent. Start dishwasher immediately.
	If using a gel detergent, the detergent may be left in dispenser too long before using.	Start dishwasher soon after adding gel detergent. Do not allow detergent to dry out in the dispenser.
	Faulty cover.	Do not overfill. Cover should close tightly. Check cover for fit.
	Improper loading.	Do not place large items in front part of dishwasher.
	Old detergent.	Use detergent within one or two months of purchase. To assure freshness, buy detergent as needed and no more than one or two at a time. Store in a cool, dry place.
	Tablet not dissolving.	Select longer wash program.
Chipping and breakage of dishes / glasses.	Improper loading.	Load with care following the instructions for use. Place glassware so it does not touch the other dishes. Remove from dishwasher carefully.
Odour in dishwasher.	Dishes washed only every two or three days.	Use the pre-wash cycle at least once a day until a load accumulates, or hand rinse dishes before loading the dishwasher.
	A dirty filter system may contribute to a bad odour.	Clean filter system.
	Using low temperature programs constantly.	Run a service wash program.

YOUR GUARANTEE

Product Guarantee Details (UK only)

Your appliance has the benefit of a comprehensive manufacturer's guarantee which covers the cost of breakdown repairs. (Details of which are shown on your Proof of Purchase Document).

- Any claim during the period of the guarantee MUST BE ACCOMPANIED BY THE PROOF OF PURCHASE.
- The product must be correctly installed and operated in accordance with the manufacturer's instructions and used for normal domestic purposes.
- This guarantee does not cover accidental damage, misuse or alterations which are likely to affect the product.
- The guarantee is invalid if the product is tampered with, or repaired by any unauthorised person.

(The guarantee in no way affects your statutory or legal right)

What to do if you need to report a problem.

Please ensure you have ready:

- The product's model and serial numbers.
- Howdens Proof of Purchase Document.
- Your full contact details.

Call the Depot number on your Proof of Purchase Document supplied with the product/kitchen.

or

Call the LAMONA Service Line on 0845 00 60 006

* Product installed within a domestic kitchen or a non-domestic kitchen where 8 or fewer people are using the appliance.

Where to find the model and serial number on your machine.	On the right-hand edge of the door.
---	--

9 - Product fiche

PRODUCT FICHE

For electrical household dishwashers (complying Commission Delegated Regulation (EU) No 1059/2010)

Brand	LAMONA
Model.....	LAM8302
Loading Capacity (place settings).....	10
Energy Efficiency Class ¹	A+
Annual Energy Consumption (AEc) (kWh) ²	237
Energy Consumption (Et) (kWh) in Eco 50 Program	0.83
Power Consumption in 'off-mode' (Po) (W).....	0.35
Power Consumption in 'left-on mode' (Pl) (W).....	0.35
Annual Water Consumption (AWc) (l) ³	3640
Water Consumption (Wt) (l) in Eco 50 Program	13
Drying Efficiency Class ⁴	A
Standard Program ⁵	Eco 50
Program Duration (Tt) (min) in Eco 50 Program.....	210
Duration of the left-on mode (TI) (min).....	5
Noise Level - dB(A) re 1 pW	51
Product Type	Fully Integrated

1. Energy efficiency class 'X' on a scale from D (least efficient) to A+++ (most efficient).
2. Energy consumption 'X' kWh per year, based on 280 standard cleaning cycles using cold water fill and the consumption of low power modes. Actual energy consumption will depend on how the appliance is used.
3. Water consumption 'X' litres per year, based on 280 standard cleaning cycles. Actual water consumption will depend on how the appliance is used.
4. Drying efficiency class 'X' on a scale from G (least efficient) to A (most efficient).
5. Eco 50 is the standard cleaning cycle to which the information in the label and the fiche relates. This program is suitable to clean normally soiled tableware, and it is the most efficient program in terms of combined energy and water consumption.

10 - Specifications

Specifications

Load capacity.....	10 Place setting
Height	820mm
Width	448mm
Depth.....	570mm
Net weight	32kg
Supply voltage	220-240 V ~ 50 Hz
Fuse current.....	13 Amp
Total power.....	2200 W
Heater power	1900 W
Pump power.....	90/30 W
Diameter of plate for;	
Upper basket	25cm maximum
Lower basket	31cm maximum

Because we continually strive to improve our products, we may change our specifications and designs without prior notice.

Note for Testing Institutes

The necessary information for performance testing will be provided upon request. The request can be done by e-mail through:

dishwasher@standardloading.com

Please do not forget to write the model code ,stock code and serial number information of the appliance besides your contact information in the e-mail.

The model code, stock code and serial number information can be found on the rating label, which is placed on the side of the door.



Product serial number

LAMONA

Exclusive to Howdens Joinery Co.



HOWDENS
JOINERY CO.

MAKING SPACE MORE VALUABLE

Howden Joinery Ltd, First Floor, 40 Portman Square, London, W1H 6LT.
Registered in England 526923



Product information correct at the time of publication in July 2015.
The company has a policy of continuous product development and reserves the right to change any products and specifications given in this manual. Subject to the Terms and Conditions of Trading, a copy of the Howdens Joinery Terms and Conditions is available upon request.